

Panasonic

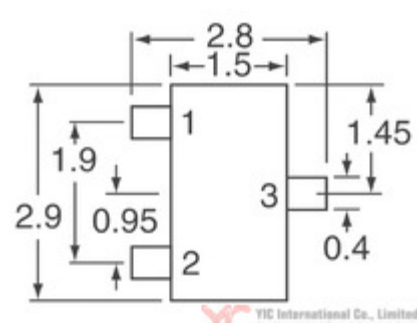

Image may be representation.
See specs for product details.

DSC200100L

Manufacturer Part Number:	DSC200100L
Manufacturer/Brand:	Panasonic
Part of Description:	TRANS NPN 50V 0.1A MINI3
RoHs Status:	Lead free / RoHS
Stock Condition:	Compliant New original, 804190 pcs Stock Available.
Ship From:	Hong Kong
Shipment Way:	DHL/Fedex/TNT/UPS/EMS

Specifications

Part Number	DSC200100L
Manufacturer	Panasonic
Description	TRANS NPN 50V 0.1A MINI3
Category	Discrete Semiconductor Products > Transistors - Bipolar
Part Status	804190 pcs Stock
Voltage - Collector Emitter Breakdown (Max)	50V
Vce Saturation (Max) @ Ib, Ic	300mV @ 10mA, 100mA
Transistor Type	NPN
Supplier Device Package	Mini3-G3-B
Series	-
Power - Max	200mW
Packaging	Tape & Reel (TR)
Package / Case	TO-236-3, SC-59, SOT-23-3
Operating Temperature	150°C (TJ)
Mounting Type	Surface Mount
Frequency - Transition	150MHz
DC Current Gain (hFE) (Min) @ Ic, Vce	210 @ 2mA, 10V
Current - Collector Cutoff (Max)	100µA
Current - Collector (Ic) (Max)	100mA

DSC200100L Electronic Components is 100% New Original from YIC Distributor, Search DSC200100L Datasheets, PDF, Inventory at Y-IC.com Online, Order DSC200100L Panasonic with Warrantied and Confidence. Ship by DHL/FedEx/TNT/UPS Express. Support Payment with Telegraphic Transfer(T/T) or PayPal.

RFQ DSC200100L Email: Info@Y-IC.com

You May Be Also Be interested

In:

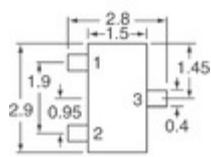

DSC2001R0L
Panasonic Electronic Components
TRANS NPN 50V 0.1A MINI3

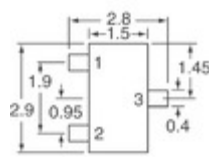

DSC2001S0L
Panasonic Electronic Components
TRANS NPN 50V 0.1A MINI3

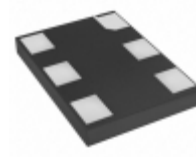

DSC1124NI1-156.2500T
Microchip Technology
OSC MEMS 156.2500MHZ HCSSL
SMD

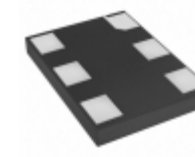

DSC1124NL2-100.0000
Microchip Technology
OSC MEMS 100.000MHZ HCSSL
SMD

Panasonic

DSC2001Q0L
Panasonic Electronic Components
TRANS NPN 50V 0.1A MINI3-G3-B

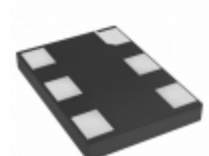

DSC1124NL2-100.0000T
Microchip Technology
OSC MEMS 100.000MHZ HCSSL
SMD



DSC14C88M
NA
NA QFN-14

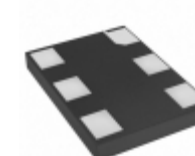

DSC1124NI1-156.2500
Microchip Technology
OSC MEMS 156.25MHZ HCSSL
SMD

DSC200100L Related keyword

More

DSC200100L Panasonic	DSC200100L Data Sheet	DSC200100L Datasheets	DSC200100L PDF	Panasonic DSC200100L
DSC200100L Electronic	DSC200100L Components	DSC200100L Distributor	DSC200100L Image	DSC200100L Part
DSC200100L Price	DSC200100L Manufacturer	DSC200100L Picture	DSC200100L Stock	DSC200100L Inventory
DSC200100L New	DSC200100L Original	DSC200100L Warranted	DSC200100L RFQ	DSC200100L Order Online

Contact us: Info@Y-IC.com

ADD:Unit A5-B5 No.509, 5/F Sing Win Factory Building, 15-17 Shing yip St, Kwun Tong, Kowloon, HongKong.

Copyright © 2020 YIC International Co., Limited