

KSPU SERIES

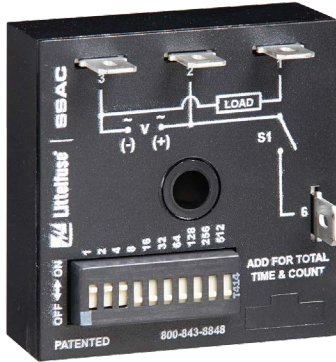

Wiring Diagram

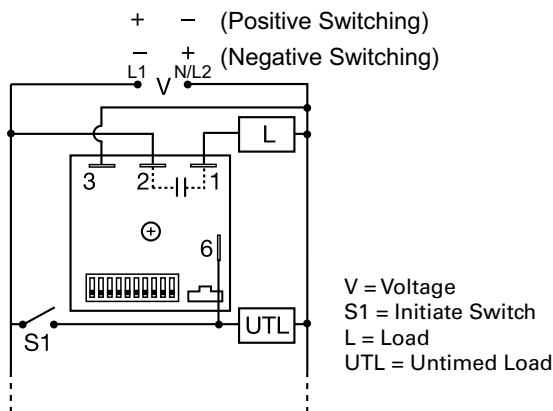



Description

The KSPU Series is a factory programmed module available in any 1 of 14 standard functions. The KSPU offers a single adjustable timer or counter function. Switch adjustment allows accurate selection of the time delay or number of counts the first time and every time. The 1A steady, 10A inrush rated solid-state output provides 100 million operations, typical. Its microcontroller timing circuit provides excellent repeat accuracy and stability. Encapsulation protects against shock, vibration, and humidity. The KSPU Series is a cost effective approach for OEM applications that require small size, solid state reliability, and accurate switch adjustment.

Features & Benefits

FEATURES	BENEFITS
Microcontroller based	Repeat Accuracy + / - 0.1%
Compact design	Allows flexibility for OEM applications
1A steady, 10A inrush solid-state output	Provides 100 million operations in typical conditions.
Totally solid state and encapsulated	No moving parts to arc and wear out over time and encapsulated to protect against shock, vibration, and humidity

Accessories

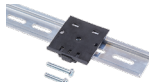
- 
P1015-64 (AWG 14/16), P1015-14 (AWG 18/22) Female Quick Connect
 These 0.25 in. (6.35 mm) female terminals are constructed with an insulator barrel to provide strain relief.
- 
P1015-18 Quick Connect to Screw Adapter
 Screw adapter terminal designed for use with all modules with 0.25 in. (6.35 mm) male quick connect terminals.
- 
C103PM (AL) DIN Rail
 35 mm aluminum DIN rail available in a 36 in. (91.4 cm) length.
- 
P1023-20 DIN Rail Adapter
 Allows module to be mounted on a 35 mm DIN type rail with two #10 screws.

Ordering Information

MODEL	INPUT VOLTAGE	TIME DELAY/COUNTS	FUNCTION
KSPUA2I	24 to 240VAC	1 - 1023s	Interval
KSPUA8C	24 to 240VAC	1 - 1023 counts (binary) with pulsed output	Counter with pulsed output

If you don't find the part you need, call us for a custom product 800-843-8848

KSPU SERIES

Specifications

Time Delay

Range* 0.1 - 102.3s, m or h in 0.1s, m or h increments
 1 - 1023s, m or h in 1s, m or h increments
 1 - 63s or m in 1s or m increments

Repeat Accuracy ±0.1% or 20 ms, whichever is greater

Setting Accuracy ≤ ±1% or 20 ms, whichever is greater

Reset Time ≤ 150ms

Initiate Time ≤ 20ms

Time Delay vs. Temperature & Voltage

≤ ±2%

Input

Voltage/Tolerance 24 to 240VAC, 12 to 120VDC/±15%

AC Line Frequency/DC Ripple 50/60 Hz/≤ 10%

Power Consumption AC ≤ 2VA; DC ≤ 1W

Output

Type Solid state

Form NO, SPST-NO

Rating 1A steady state, 10A inrush for 16ms

Voltage Drop AC ≅ 2.5V @ 1A; DC ≅ 1V @ 1A

Off State Leakage Current AC ≅ 5mA @ 240VAC; DC ≅ 1 mA

Counter Output Output pulse width: 300ms ±20%

Time Delay/Counts Variable 7 & 8

Protection

Circuitry Encapsulated

Dielectric Breakdown ≥ 2000V RMS terminals to mounting surface

Insulation Resistance ≥ 100 MΩ

Polarity DC units are reverse polarity protected

Mechanical

Mounting Surface mount with one #10 (M5 x 0.8) screw

Dimensions **H** 50.8 mm (2"); **W** 50.8 mm (2");

D 30.7 mm (1.21")

0.25 in. (6.35 mm) male quick connect terminals

Termination

Environmental

Operating/Storage Temperature -40° to 60°C / -40° to 85°C

Humidity 95% relative, non-condensing

Weight ≅ 2.4 oz (68 g)

*For CE approved applications, power must be removed from the unit when a switch position is changed.

Adjustment Switch Operation

TIME DELAY		COUNTER	
0.1...102.3	1...1023	1...165	1...63
OFF ▶ ON	OFF ▶ ON	OFF ▶ ON	OFF ▶ ON
0.1	1	1	T
0.2	2	2	2
0.4	4	3	4
0.8	8	4	8
1.6	16	5	16
3.2	32	10	32
6.4	64	20	M*
12.8	128	30	1
25.6	256	40	2
51.2	512	50	4
6.3	544	57 counts	44 s Delay 2 counts to Start

* for selecting time in minutes or seconds

Function Diagrams

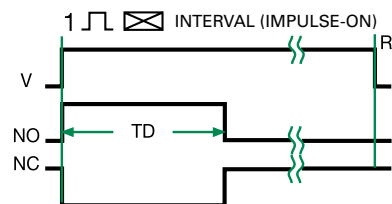
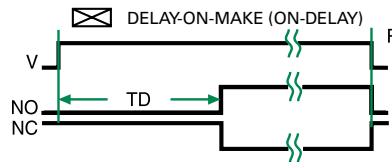

V = Voltage
 NO = Normally Open Contact
 NC = Normally Closed Contact
 TD = Time Delay
 R = Reset
 = Undefined Time