



STL11N4LLF5

N-channel 40 V, 9.1 mΩ typ., 15 A STripFET™V Power MOSFET
in a PowerFLAT™ 3.3 x 3.3 package

Datasheet – production data

Features

Order code	V _{DS}	R _{DS(on)} max	I _D
STL11N4LLF5	40 V	9.7 mΩ	15 A

- Low gate charge
- Very low on-resistance
- High avalanche ruggedness

Applications

- Switching applications

Description

This device is an N-channel Power MOSFET developed using STMicroelectronics' STripFET™V technology. The device has been optimized to achieve very low on-state resistance, contributing to a FOM that is among the best in its class.

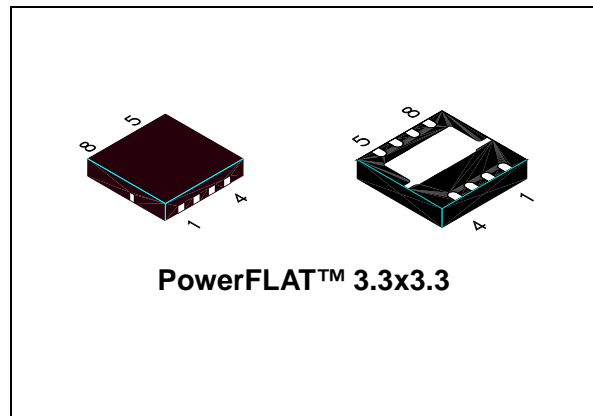

Figure 1. Internal schematic diagram

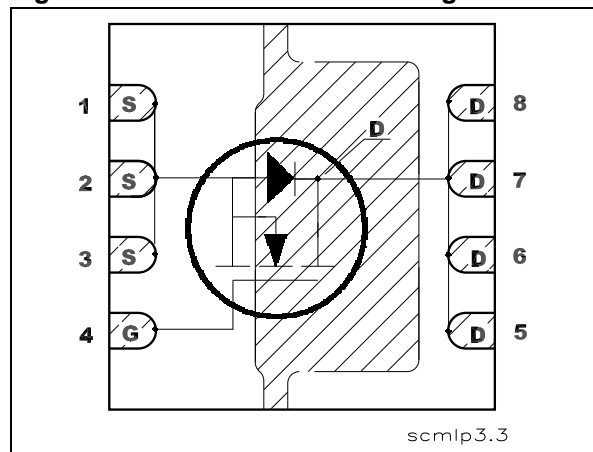

Table 1. Device summary

Order code	Marking	Package	Packaging
STL11N4LLF5	11N4LLF5	PowerFLAT™ 3.3 x 3.3	Tape and reel

Contents

1	Electrical ratings	3
2	Electrical characteristics	4
	2.1 Electrical characteristics (curves)	6
3	Test circuits	8
4	Package mechanical data	9
5	Revision history	13

1 Electrical ratings

Table 2. Absolute maximum ratings

Symbol	Parameter	Value	Unit
V_{DS}	Drain-source voltage	40	V
V_{GS}	Gate-source voltage	± 20	V
$I_D^{(1)}$	Drain current (continuous) at $T_{pcb} = 25\text{ }^\circ\text{C}$	11	A
$I_D^{(1)}$	Drain current (continuous) at $T_{pcb}=100\text{ }^\circ\text{C}$	6.8	A
$I_{DM}^{(2)}$	Drain current (pulsed)	44	A
$P_{TOT}^{(3)}$	Total dissipation at $T_C = 25\text{ }^\circ\text{C}$	50	W
$P_{TOT}^{(1)}$	Total dissipation at $T_{pcb} = 25\text{ }^\circ\text{C}$	2.9	W
	Derating factor ⁽³⁾	0.4	W/ $^\circ\text{C}$
T_J T_{stg}	Operating junction temperature storage temperature	-55 to 150	$^\circ\text{C}$

1. The value is rated according $R_{thj-pcb}$
2. Pulse width limited by safe operating area.
3. The vaule is rated according R_{thj-c}

Table 3. Thermal resistance

Symbol	Parameter	Value	Unit
$R_{thj-case}$	Thermal resistance junction-case	2.5	$^\circ\text{C}/\text{W}$
$R_{thj-pcb}^{(1)}$	Thermal resistance junction-pcb	42.8	$^\circ\text{C}/\text{W}$
$R_{thj-pcb}^{(2)}$	Thermal resistance junction-pcb	63.5	$^\circ\text{C}/\text{W}$

1. When mounted on FR-4 board of 1inch² , 2oz Cu, t < 10sec
2. Steady state

2 Electrical characteristics

($T_{CASE}=25^{\circ}C$ unless otherwise specified)

Table 4. On/off states

Symbol	Parameter	Test conditions	Min.	Typ.	Max.	Unit
$V_{(BR)DSS}$	Drain-source breakdown voltage	$I_D = 250 \mu A, V_{GS} = 0$	40			V
I_{DSS}	Zero gate voltage drain current ($V_{GS} = 0$)	$V_{DS} = 40 V,$ $V_{DS} = 40 V, T_C = 125^{\circ}C$			1 10	μA μA
I_{GSS}	Gate body leakage current ($V_{DS} = 0$)	$V_{GS} = \pm 20 V$			± 100	μA
$V_{GS(th)}$	Gate threshold voltage	$V_{DS} = V_{GS}, I_D = 250 \mu A$	1		2.5	V
$R_{DS(on)}$	Static drain-source on-resistance	$V_{GS} = 10 V, I_D = 5.5 A$ $V_{GS} = 4.5 V, I_D = 5.5 A$		9.1 10.6	9.7 12	$m\Omega$ $m\Omega$

Table 5. Dynamic

Symbol	Parameter	Test conditions	Min.	Typ.	Max.	Unit
C_{iss}	Input capacitance	$V_{DS} = 25 V, f = 1 MHz,$ $V_{GS} = 0$		1570		pF
C_{oss}	Output capacitance			257		pF
C_{rss}	Reverse transfer capacitance			32		pF
Q_g	Total gate charge	$V_{DD} = 15 V, I_D = 11 A$		12.9		nC
Q_{gs}	Gate-source charge	$V_{GS} = 4.5 V$		3.9		nC
Q_{gd}	Gate-drain charge	(see Figure 14)		5.3		nC
R_G	Gate input resistance	$f = 1 MHz$ Gate DC Bias = 0 Test signal level = 20 mV $I_D = 0$	0.5	1.5	2.5	Ω

Table 6. Switching times

Symbol	Parameter	Test conditions	Min.	Typ.	Max.	Unit
$t_{d(on)}$	Turn-on delay time	$V_{DD} = 15 V, I_D = 5.5 A,$ $R_G = 4.7 \Omega, V_{GS} = 4.5 V$ (see Figure 13)		14		ns
t_r	Rise time			42		ns
$t_{d(off)}$	Turn-off delay time		-	37	-	ns
t_f	Fall time			5.2		ns

Table 7. Source drain diode

Symbol	Parameter	Test conditions	Min.	Typ.	Max.	Unit
I_{SD}	Source-drain current		-		11	A
$I_{SDM}^{(1)}$	Source-drain current (pulsed)		-		44	A
$V_{SD}^{(2)}$	Forward on voltage	$I_{SD}=11\text{ A}$, $V_{GS}=0$	-		1.1	V
t_{rr} Q_{rr} I_{RRM}	Reverse recovery time Reverse recovery charge Reverse recovery current	$I_{SD}=11\text{ A}$, $di/dt = 100\text{ A}/\mu\text{s}$, $V_{DD}=20\text{ V}$, $T_j=150\text{ }^\circ\text{C}$ (see Figure 18)	-	27.2 24.5 1.8		ns nC A

1. Pulse width limited by safe operating area.
2. Pulsed: pulse duration=300 μs , duty cycle 1.5%

2.1 Electrical characteristics (curves)

Figure 2. Safe operating area

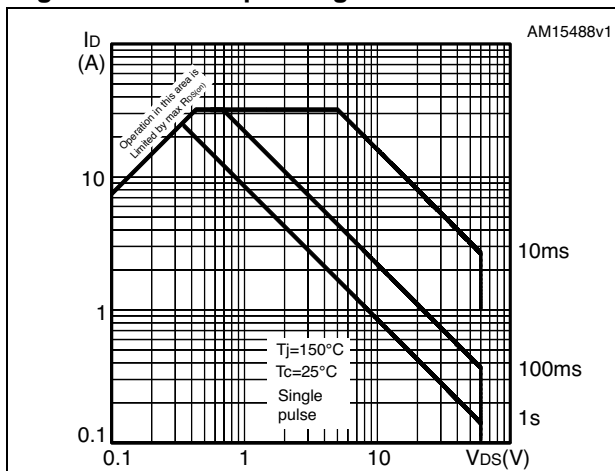

Figure 3. Thermal impedance

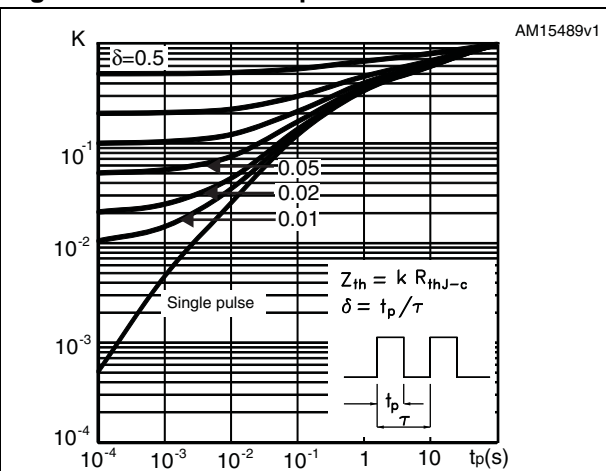

Figure 4. Output characteristics

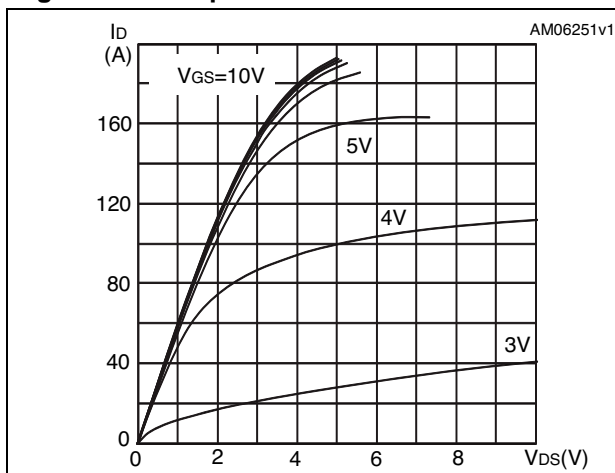

Figure 5. Transfer characteristics

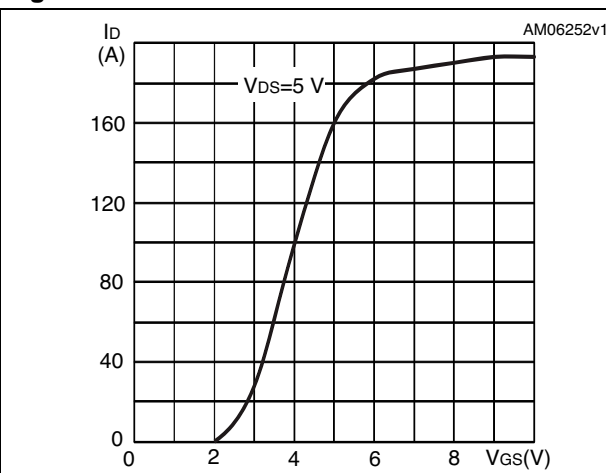

Figure 6. Normalized $B_{V_{DS}}$ vs temperature

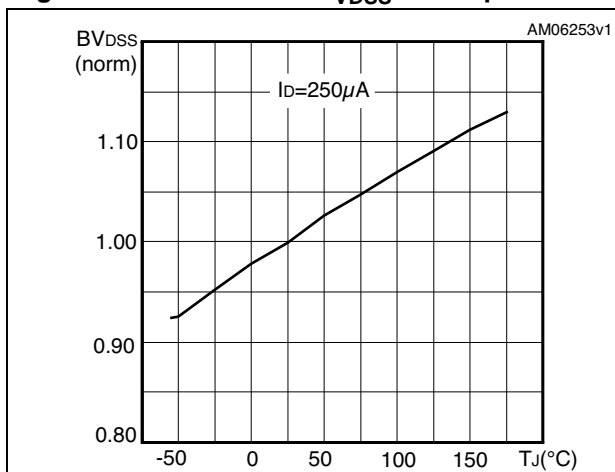

Figure 7. Static drain-source on-resistance

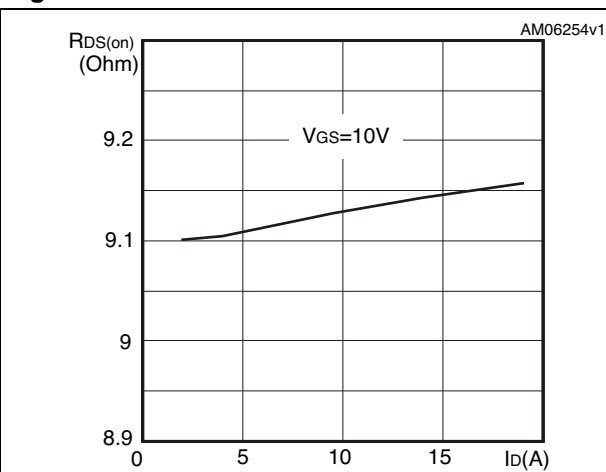

Figure 8. Gate charge vs gate-source voltage Figure 9. Capacitance variations

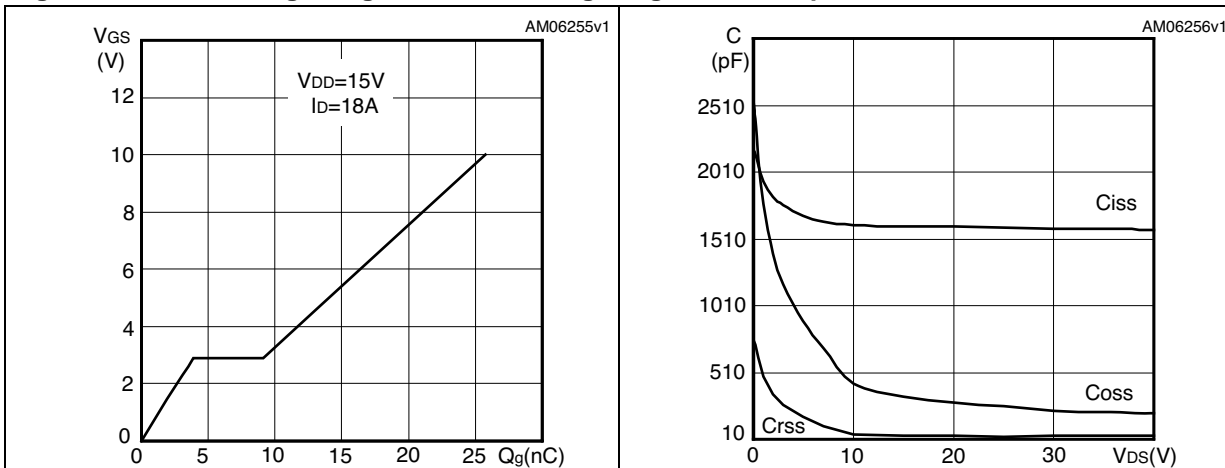

Figure 10. Normalized gate threshold voltage vs temperature Figure 11. Normalized on-resistance vs temperature

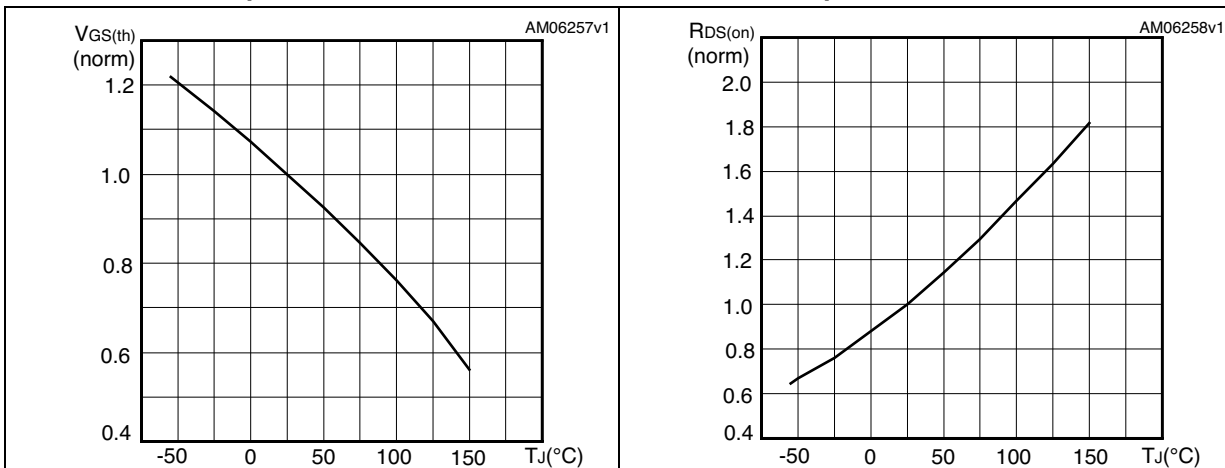
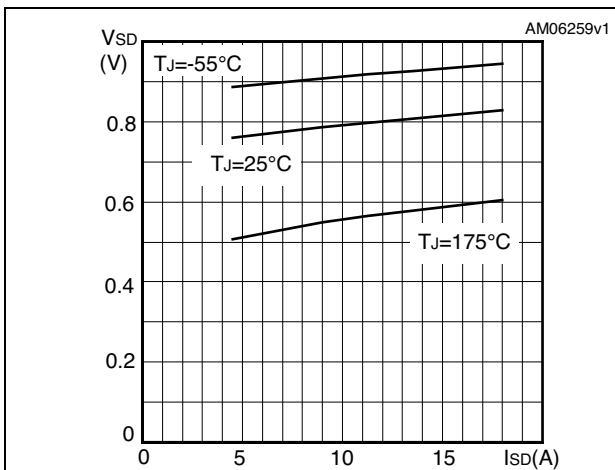

Figure 12. Source-drain diode forward characteristics



3 Test circuits

Figure 13. Switching times test circuit for resistive load



Figure 14. Gate charge test circuit

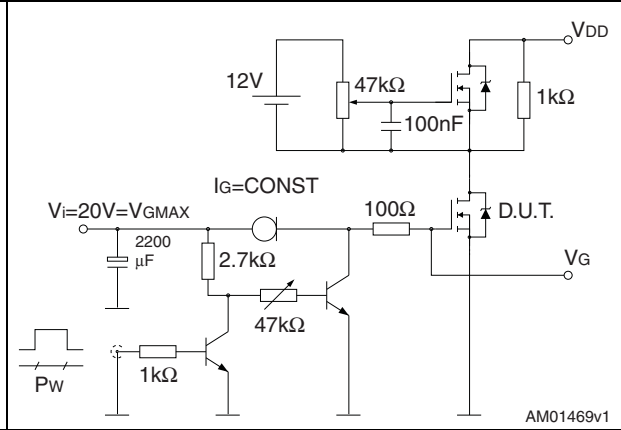

Figure 15. Test circuit for inductive load switching and diode recovery times



Figure 16. Unclamped inductive load test circuit



Figure 17. Unclamped inductive waveform

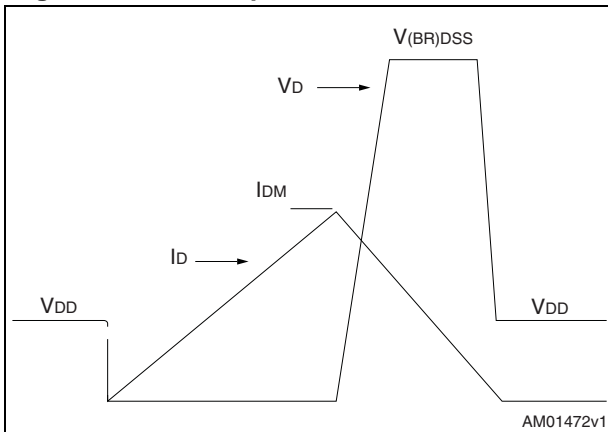
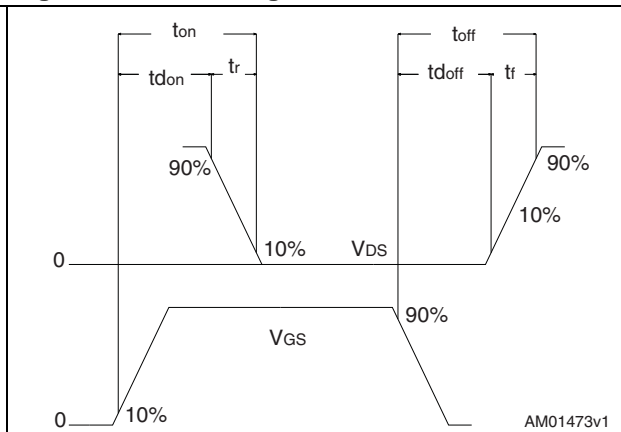

Figure 18. Switching time waveform



4 Package mechanical data

In order to meet environmental requirements, ST offers these devices in different grades of ECOPACK[®] packages, depending on their level of environmental compliance. ECOPACK[®] specifications, grade definitions and product status are available at: www.st.com. ECOPACK[®] is an ST trademark.

Table 8. PowerFLAT™ 3.3 x 3.3 mechanical data

Dim.	mm		
	Min.	Typ.	Max.
A	0.80	0.90	1.00
A1	0		0.05
A3		0.20	
b	0.23		0.38
D	3.20	3.30	3.40
D2	2.50		2.75
E	3.20	3.30	3.40
E2	1.25		1.50
e		0.65	
L	0.30		0.50

Figure 19. PowerFLAT™ 3.3 x 3.3 drawing

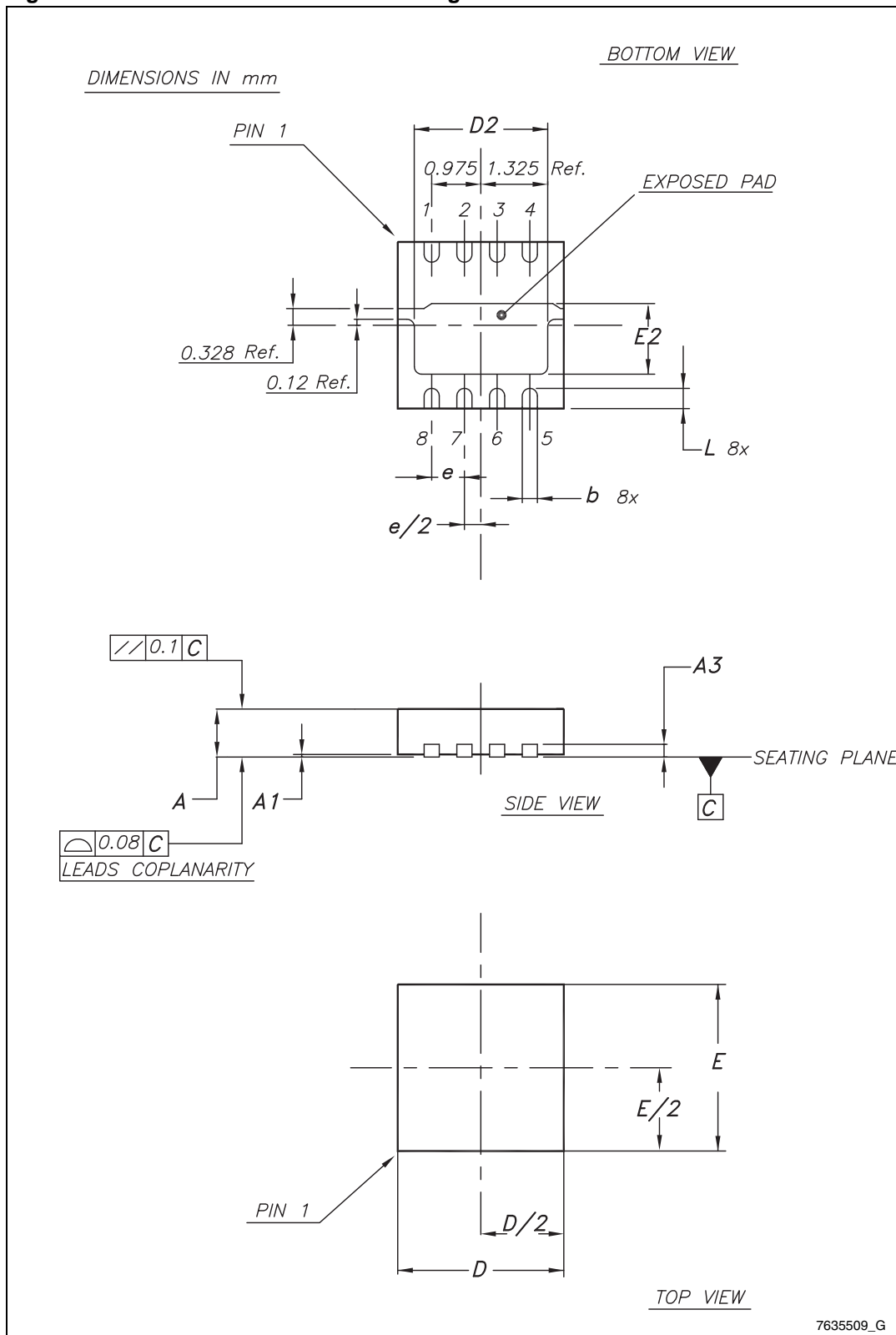
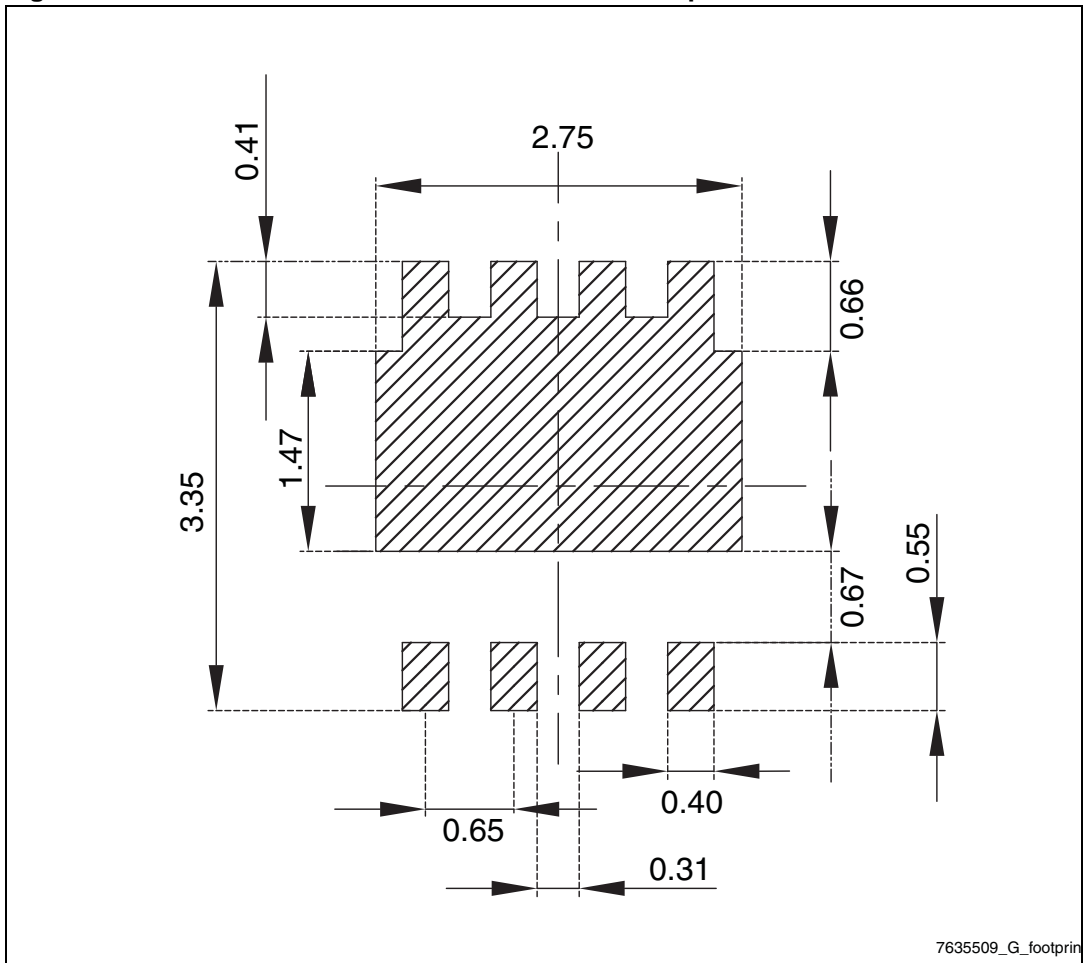

Figure 20. PowerFLAT™ 3.3 x 3.3 recommended footprint



5 Revision history

Table 9. Document revision history

Date	Revision	Changes
19-Feb-2013	1	First release

Please Read Carefully:

Information in this document is provided solely in connection with ST products. STMicroelectronics NV and its subsidiaries ("ST") reserve the right to make changes, corrections, modifications or improvements, to this document, and the products and services described herein at any time, without notice.

All ST products are sold pursuant to ST's terms and conditions of sale.

Purchasers are solely responsible for the choice, selection and use of the ST products and services described herein, and ST assumes no liability whatsoever relating to the choice, selection or use of the ST products and services described herein.

No license, express or implied, by estoppel or otherwise, to any intellectual property rights is granted under this document. If any part of this document refers to any third party products or services it shall not be deemed a license grant by ST for the use of such third party products or services, or any intellectual property contained therein or considered as a warranty covering the use in any manner whatsoever of such third party products or services or any intellectual property contained therein.

UNLESS OTHERWISE SET FORTH IN ST'S TERMS AND CONDITIONS OF SALE ST DISCLAIMS ANY EXPRESS OR IMPLIED WARRANTY WITH RESPECT TO THE USE AND/OR SALE OF ST PRODUCTS INCLUDING WITHOUT LIMITATION IMPLIED WARRANTIES OF MERCHANTABILITY, FITNESS FOR A PARTICULAR PURPOSE (AND THEIR EQUIVALENTS UNDER THE LAWS OF ANY JURISDICTION), OR INFRINGEMENT OF ANY PATENT, COPYRIGHT OR OTHER INTELLECTUAL PROPERTY RIGHT.

UNLESS EXPRESSLY APPROVED IN WRITING BY TWO AUTHORIZED ST REPRESENTATIVES, ST PRODUCTS ARE NOT RECOMMENDED, AUTHORIZED OR WARRANTED FOR USE IN MILITARY, AIR CRAFT, SPACE, LIFE SAVING, OR LIFE SUSTAINING APPLICATIONS, NOR IN PRODUCTS OR SYSTEMS WHERE FAILURE OR MALFUNCTION MAY RESULT IN PERSONAL INJURY, DEATH, OR SEVERE PROPERTY OR ENVIRONMENTAL DAMAGE. ST PRODUCTS WHICH ARE NOT SPECIFIED AS "AUTOMOTIVE GRADE" MAY ONLY BE USED IN AUTOMOTIVE APPLICATIONS AT USER'S OWN RISK.

Resale of ST products with provisions different from the statements and/or technical features set forth in this document shall immediately void any warranty granted by ST for the ST product or service described herein and shall not create or extend in any manner whatsoever, any liability of ST.

ST and the ST logo are trademarks or registered trademarks of ST in various countries.

Information in this document supersedes and replaces all information previously supplied.

The ST logo is a registered trademark of STMicroelectronics. All other names are the property of their respective owners.

© 2013 STMicroelectronics - All rights reserved

STMicroelectronics group of companies

Australia - Belgium - Brazil - Canada - China - Czech Republic - Finland - France - Germany - Hong Kong - India - Israel - Italy - Japan - Malaysia - Malta - Morocco - Philippines - Singapore - Spain - Sweden - Switzerland - United Kingdom - United States of America

www.st.com